

Name _____

Write an equation for the graph.

1)

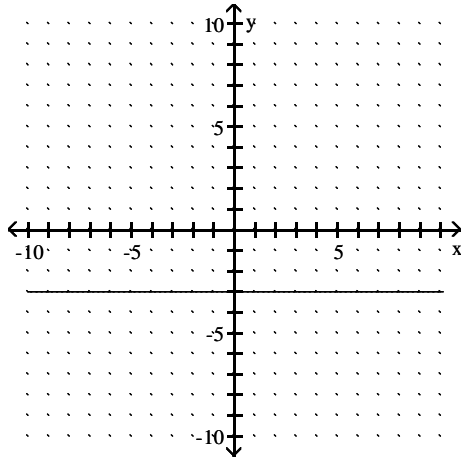

2)

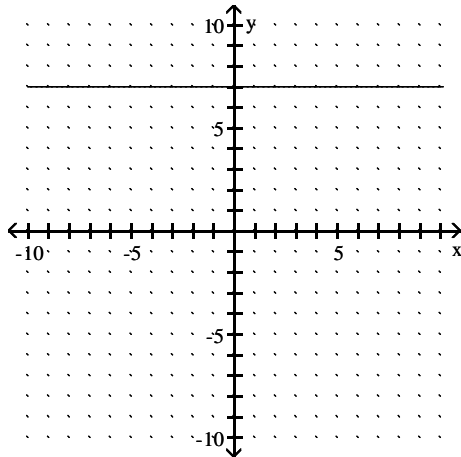

3)

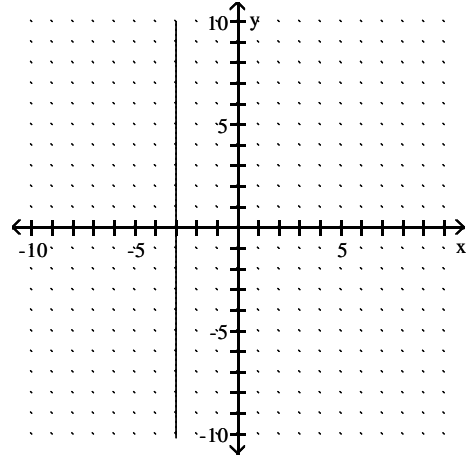

4)

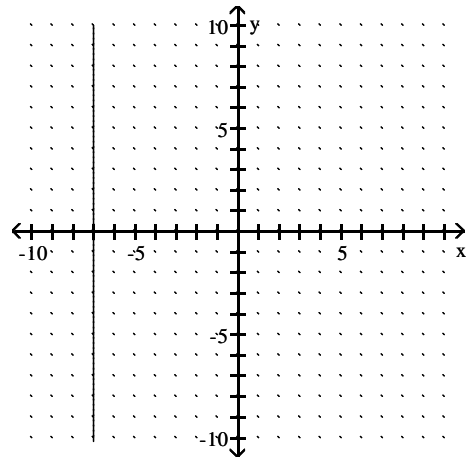

Graph the equation.

5) $y = -2$

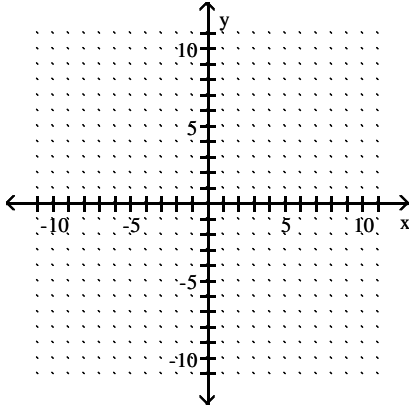

8) $x = 2$

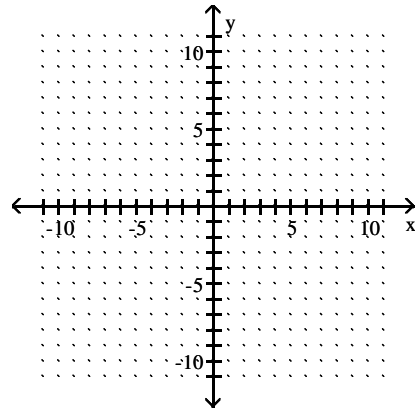

6) $y = -3$

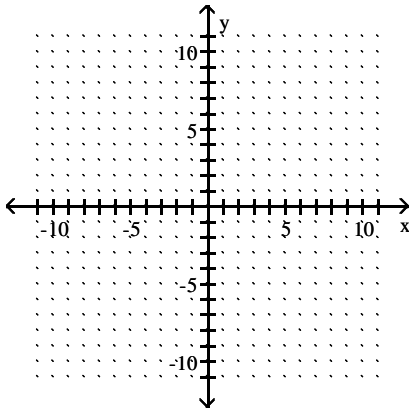

9) $y + 5 = 0$

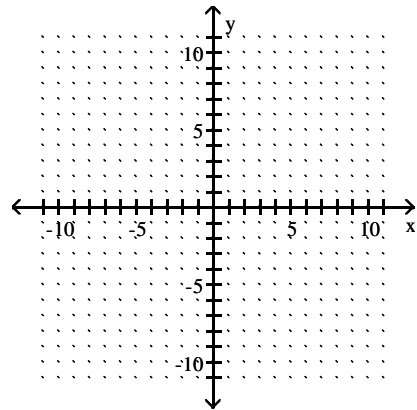

7) $x = -4$

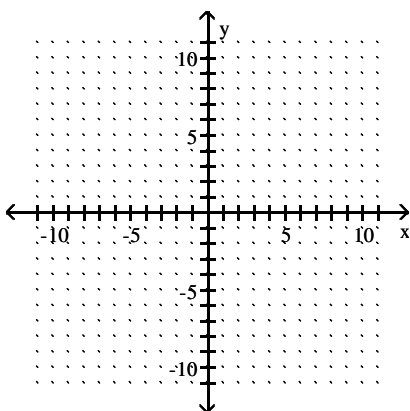

10) $y + 3 = 0$

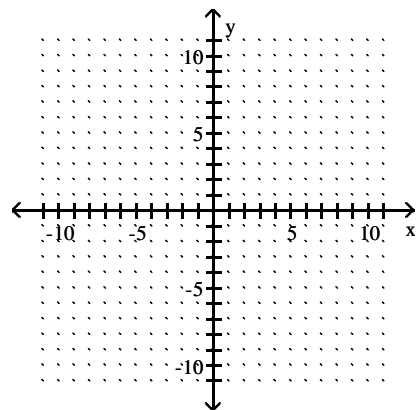

11) $x + 5 = 0$

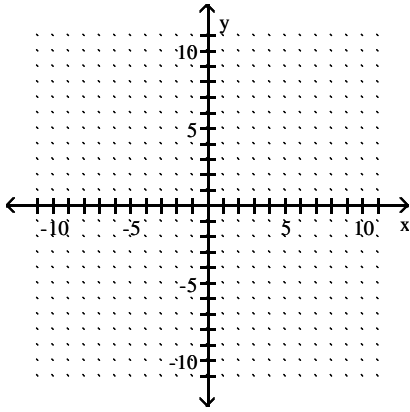

14) $12x = -60$

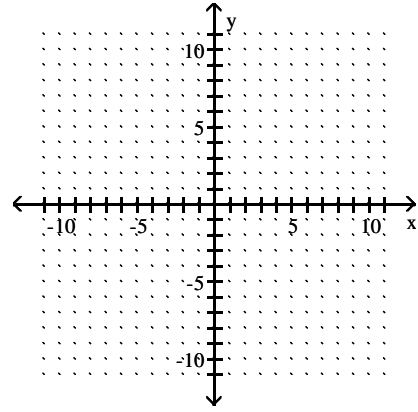

12) $x + 4 = 0$

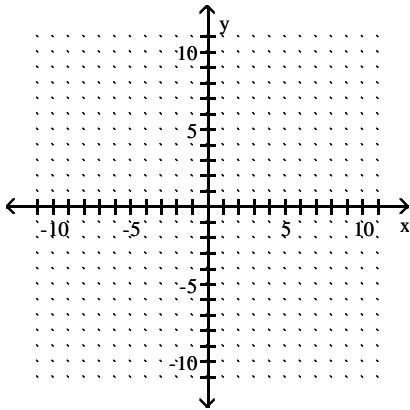

15) $19y = 38$

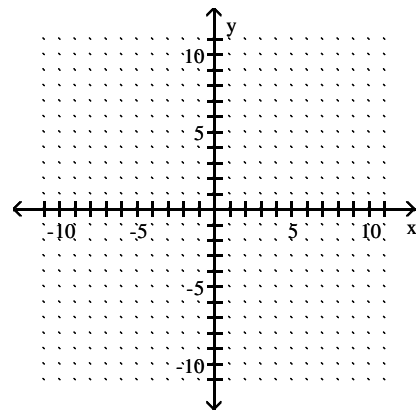

13) $16x = -32$

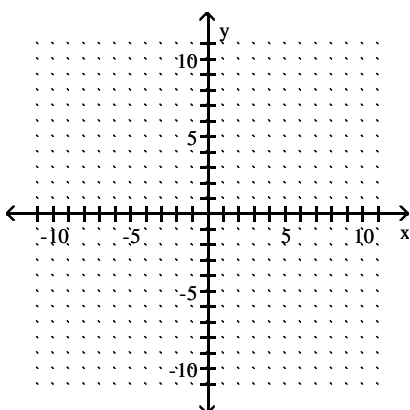

16) $19y = -38$

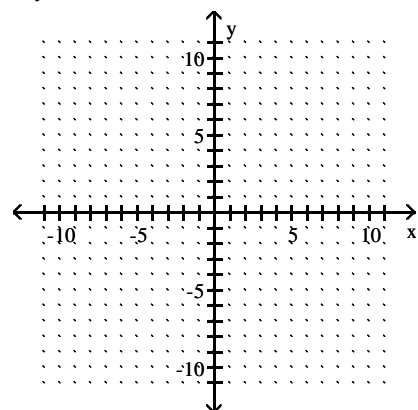

17) $5y = -20$

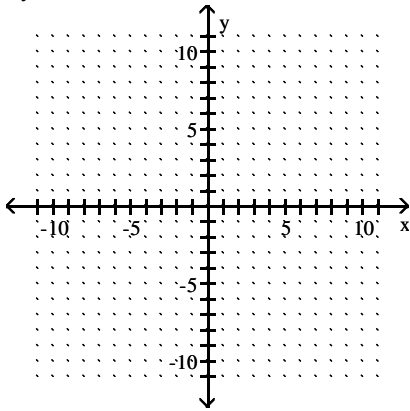

20) $y = 8$

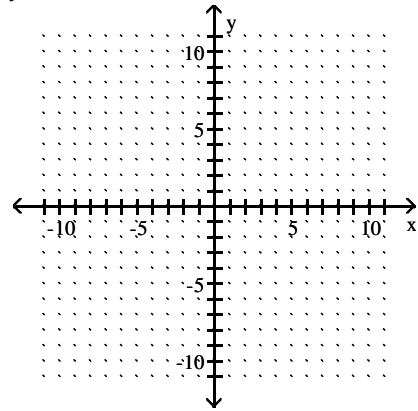

18) $85 - 17x = 0$

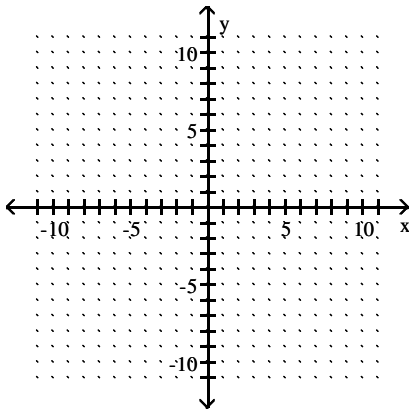

Write an equation for the graph.

21)

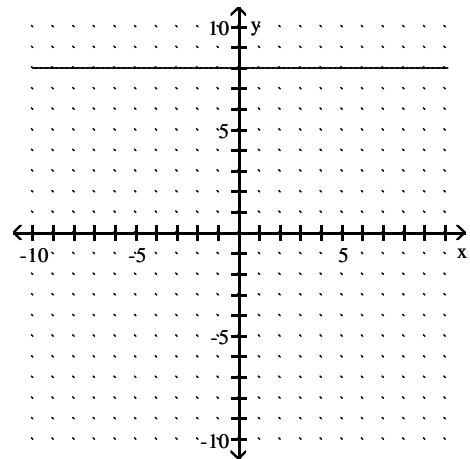

19) $39 - 13x = 0$

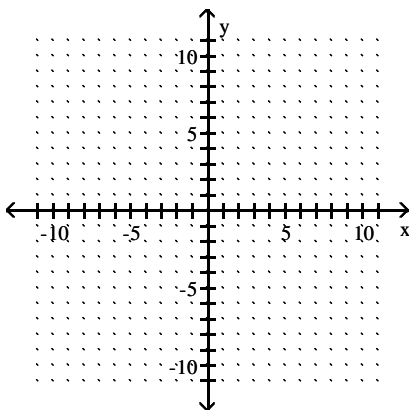

Answer Key

Testname: 04.2V01A

1) $y = -3$

2) $y = 7$

3) $x = -3$

4) $x = -7$

5)

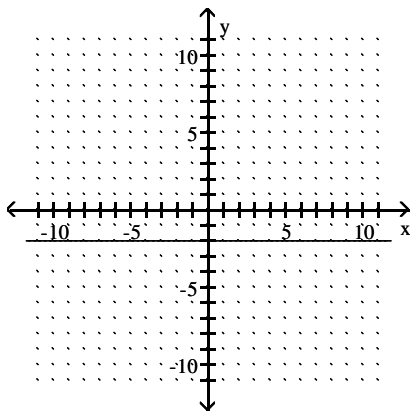

6)

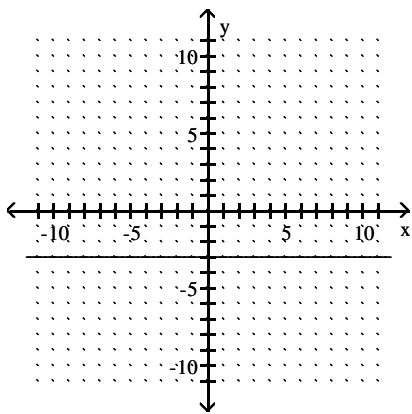

7)

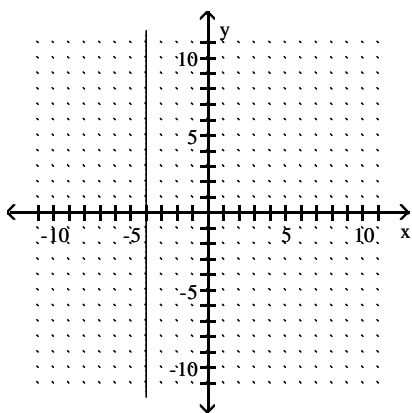

Answer Key
Testname: 04.2V01A

8)

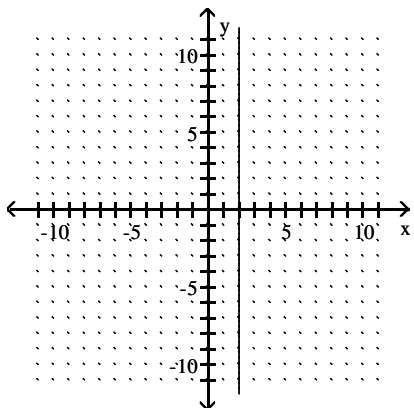

9)

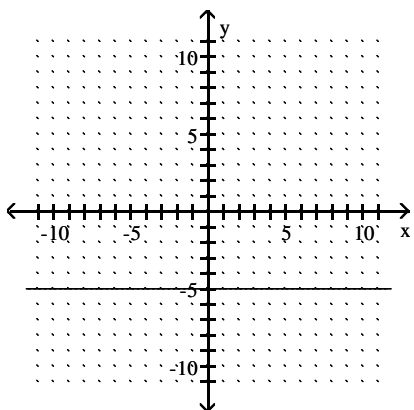

10)

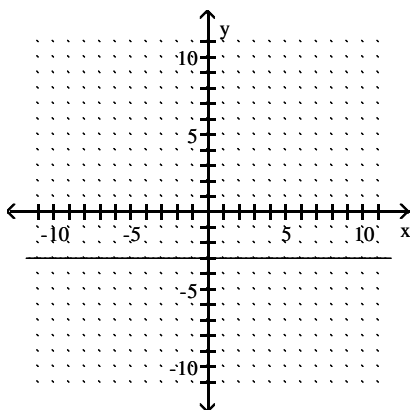

Answer Key

Testname: 04.2V01A

11)

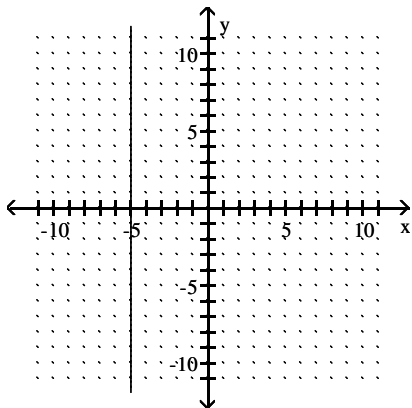

12)

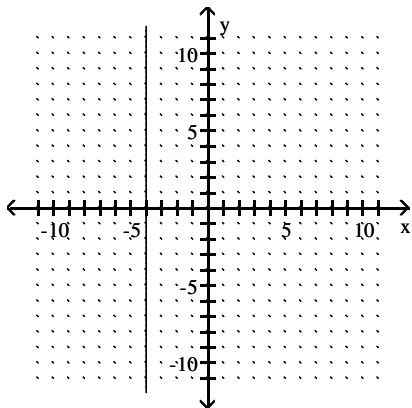

13)

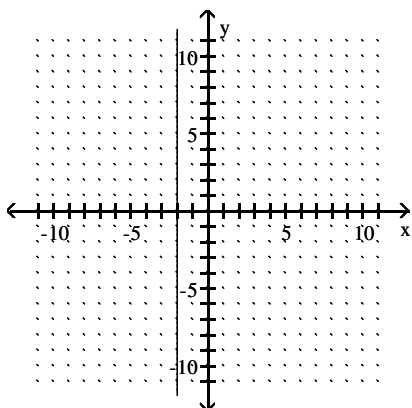

Answer Key
Testname: 04.2V01A

14)

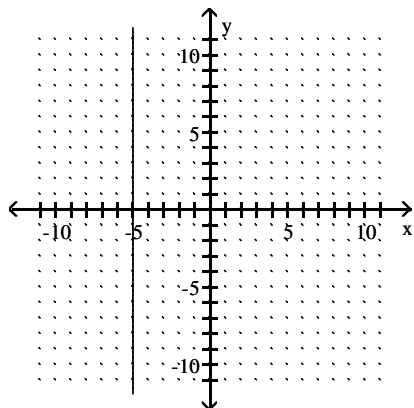

15)

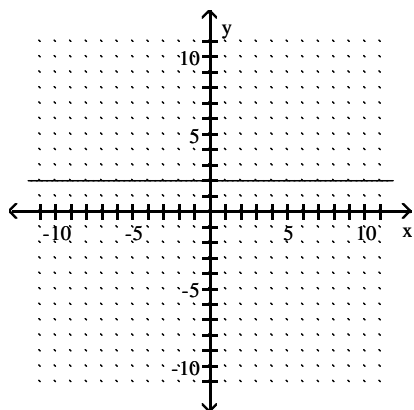

16)

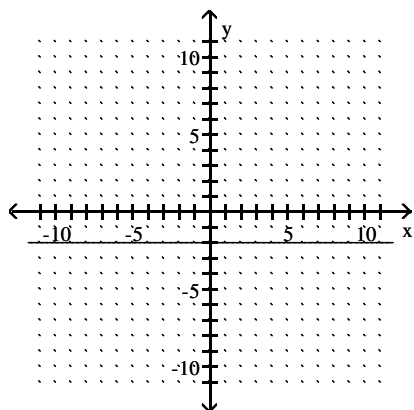

Answer Key

Testname: 04.2V01A

17)

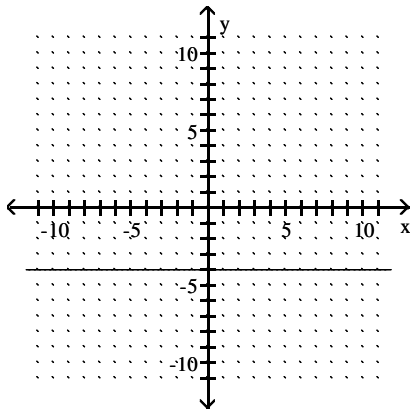

18)

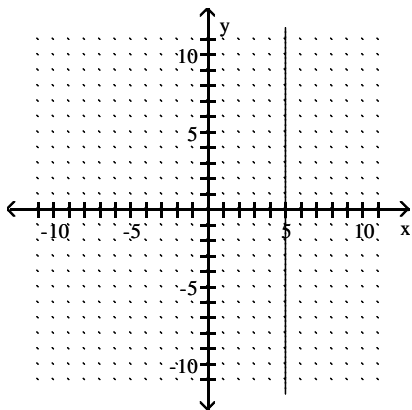

19)

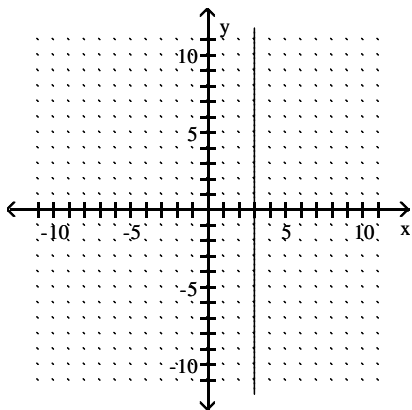

Answer Key

Testname: 04.2V01A

20)

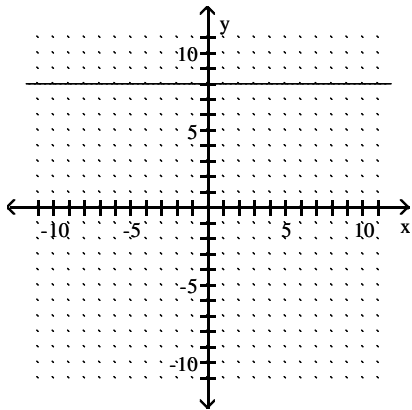

21) $y = 8$