

Name _____

Write an equation for the graph.

1)

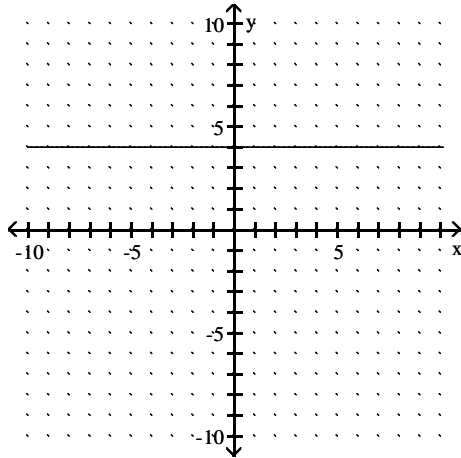

2)

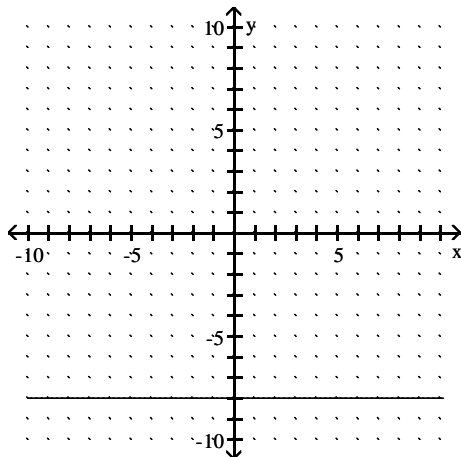

3)

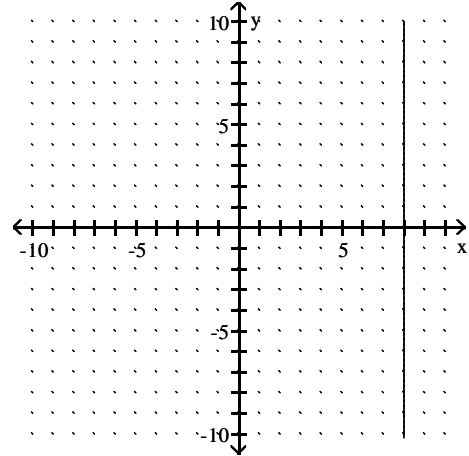

4)

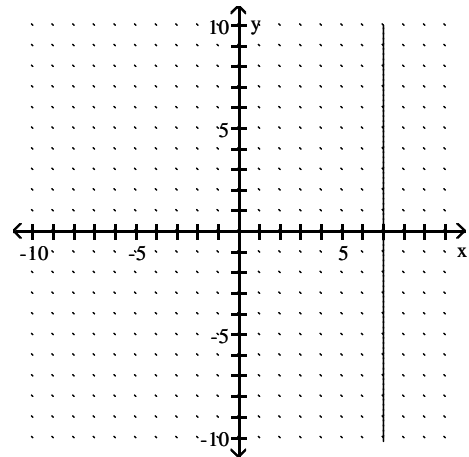

Graph the equation.

5) $y = 4$

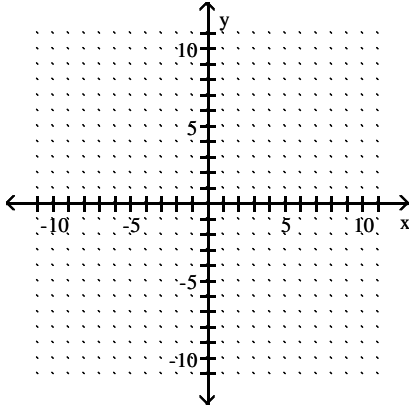

8) $x = 6$

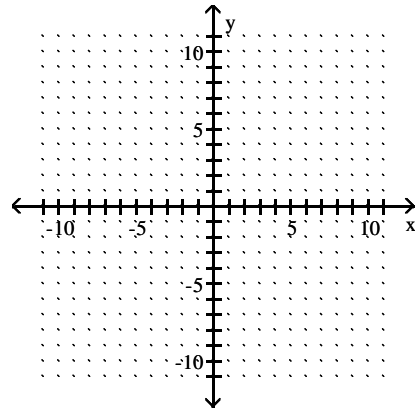

6) $y = -5$

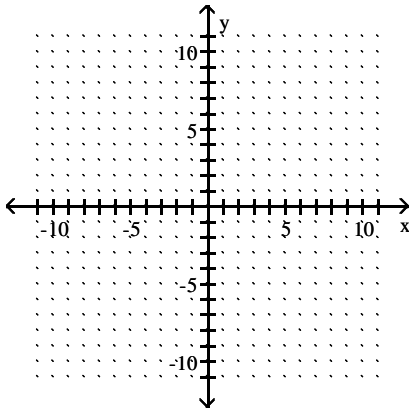

9) $y + 2 = 0$

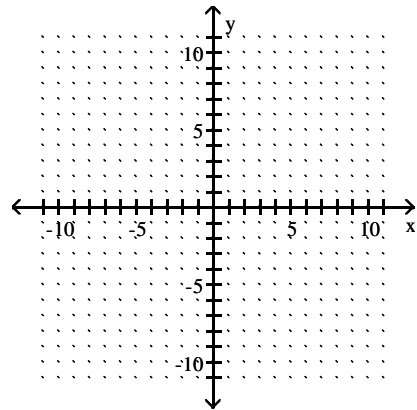

7) $x = 3$

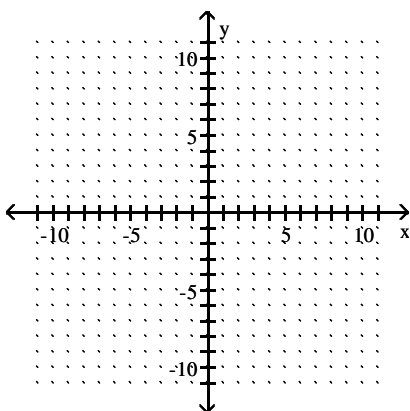

10) $y + 4 = 0$

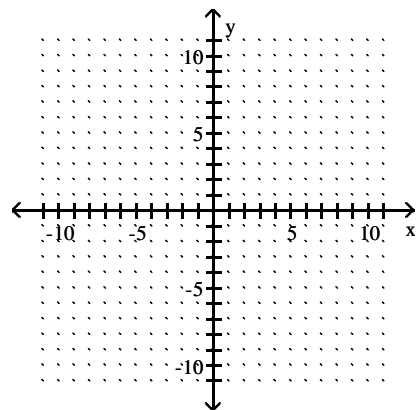

11) $x + 3 = 0$

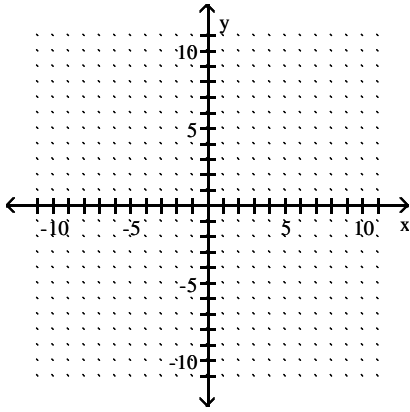

14) $2x = -8$

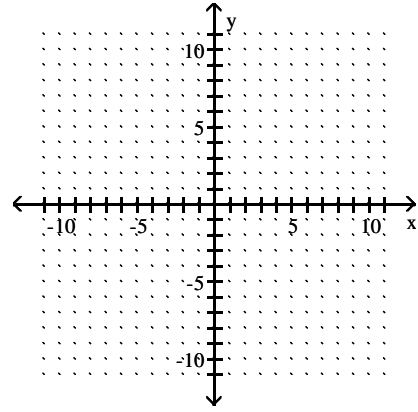

12) $x + 2 = 0$

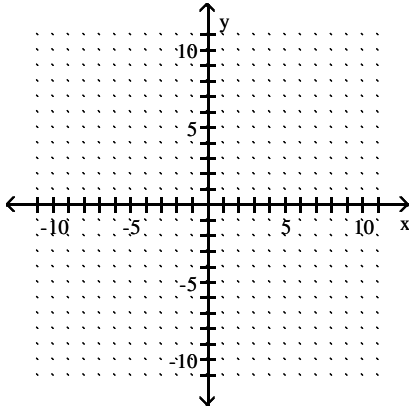

15) $6y = -30$

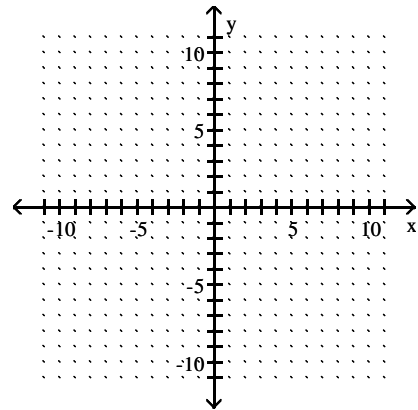

13) $2x = -2$

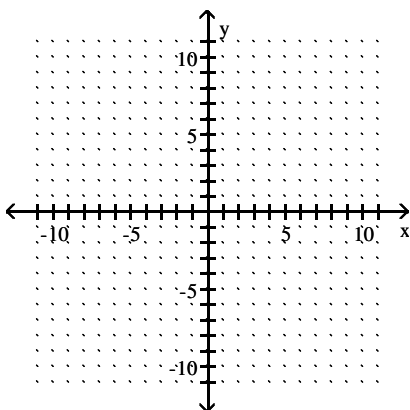

16) $6y = -12$

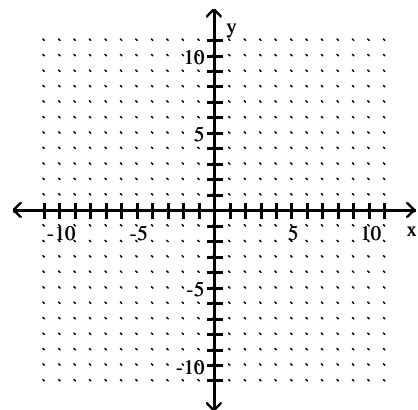

17) $14y = -14$

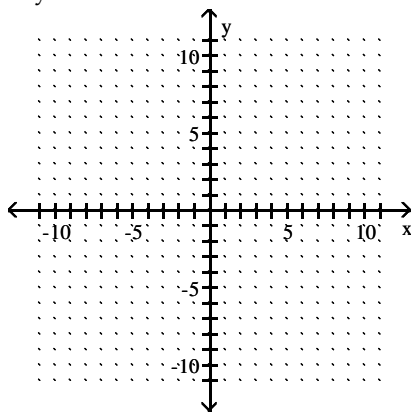

20) $y = -1$

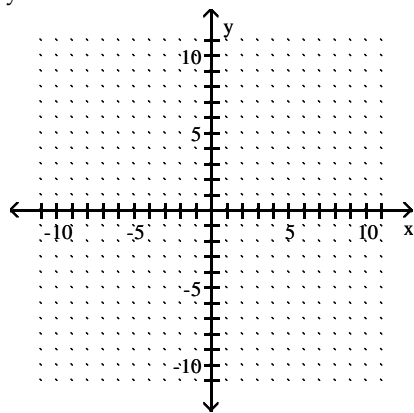

18) $6 - 2x = 0$

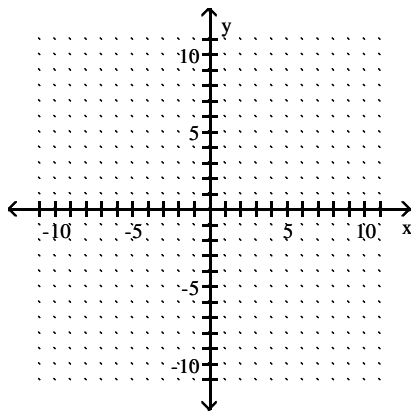

Write an equation for the graph.

21)

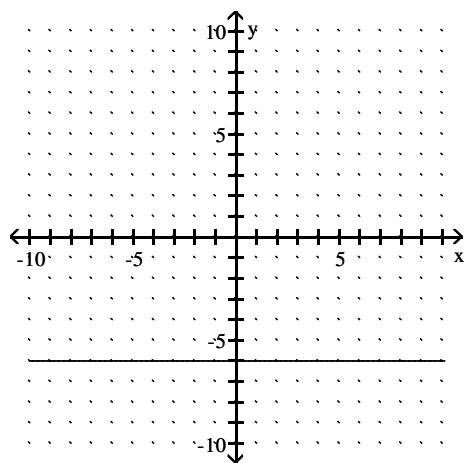

19) $44 - 11x = 0$

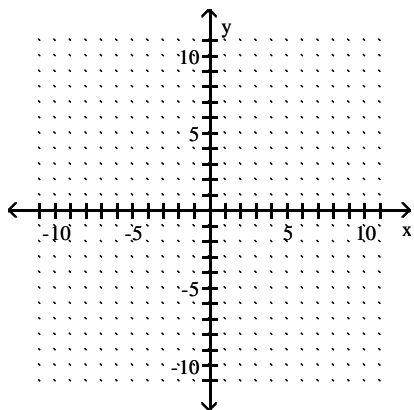

Answer Key

Testname: 04.2V02A

1) $y = 4$

2) $y = -8$

3) $x = 8$

4) $x = 7$

5)

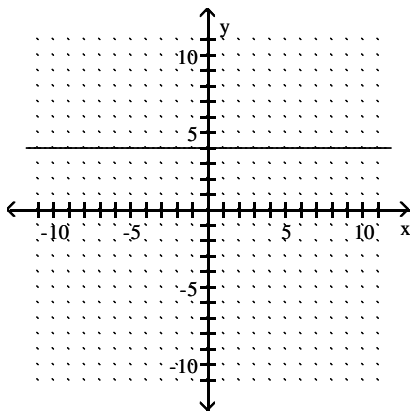

6)

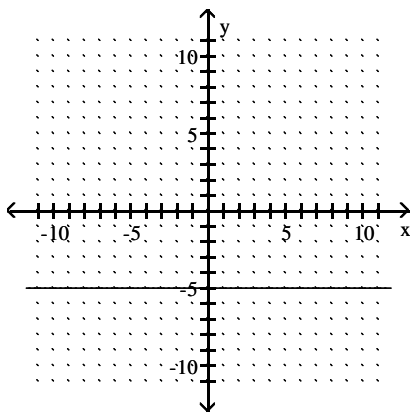

7)

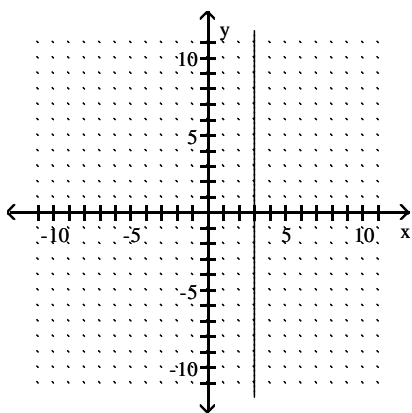

Answer Key
Testname: 04.2V02A

8)

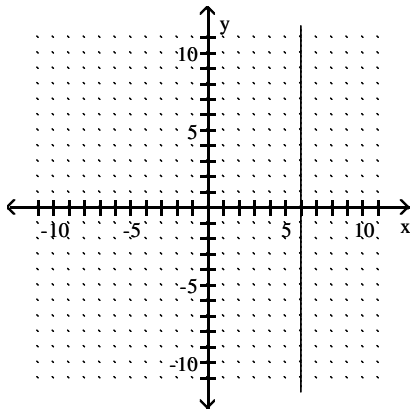

9)

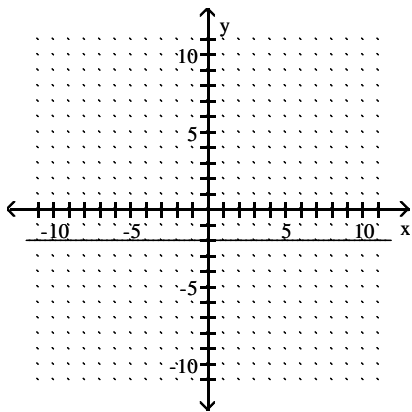

10)

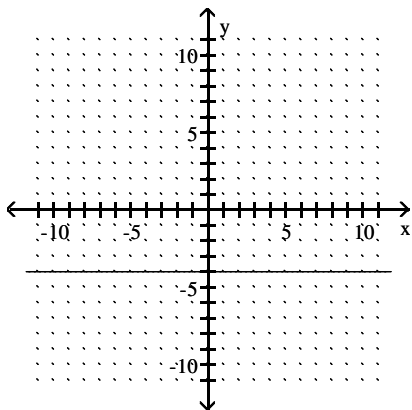

Answer Key

Testname: 04.2V02A

11)

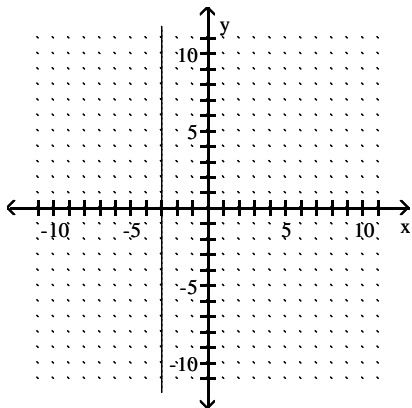

12)

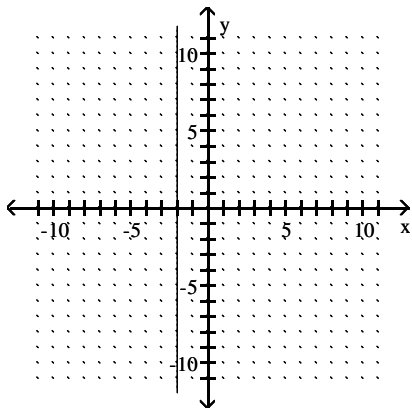

13)

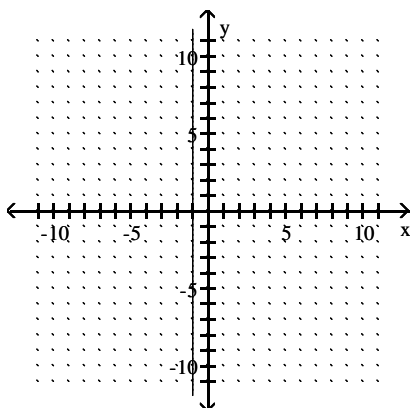

Answer Key
Testname: 04.2V02A

14)

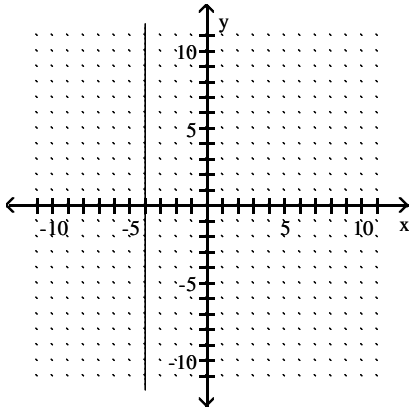

15)

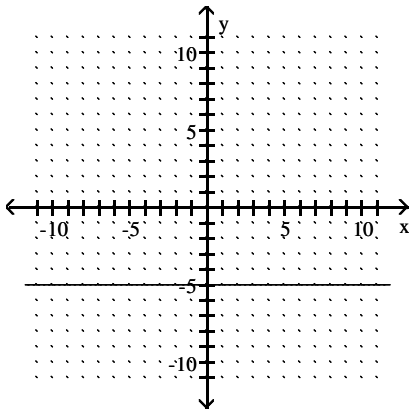

16)

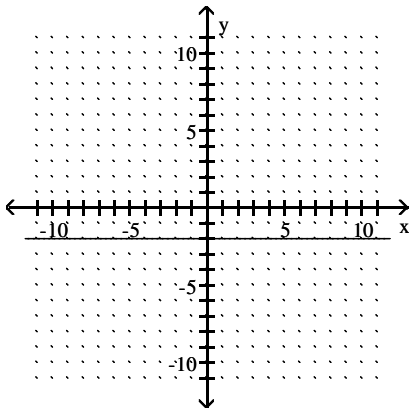

Answer Key
Testname: 04.2V02A

17)

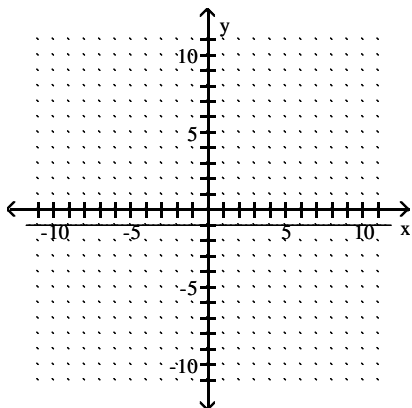

18)

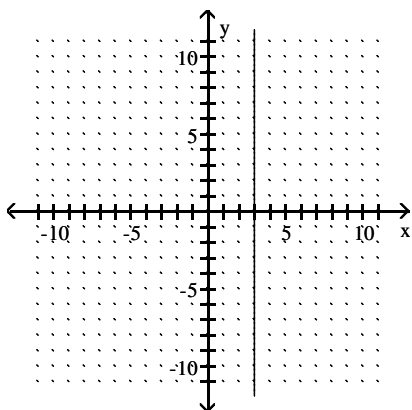

19)

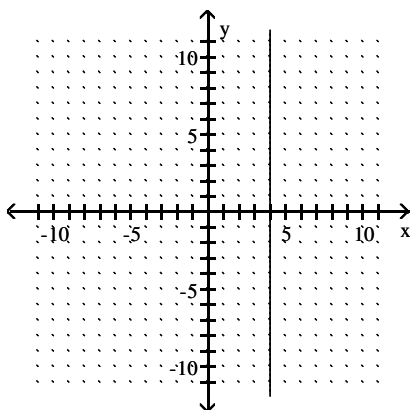

Answer Key

Testname: 04.2V02A

20)

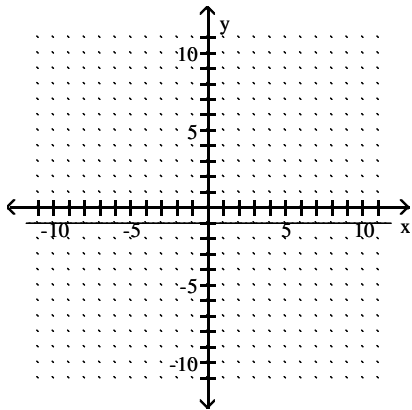

21) $y = -6$