

Name _____

Graph.

1) $y = x - 2$

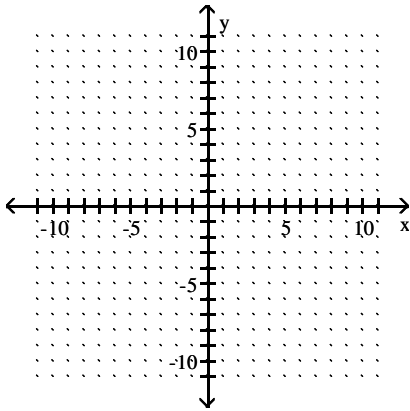

2) $y = x - 1$

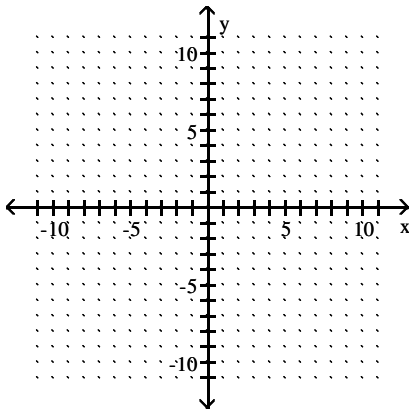

3) $y = x - 1$

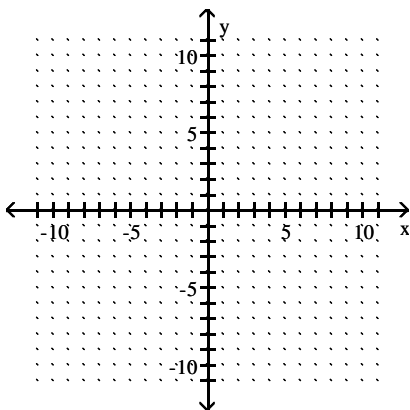

4) $y = 2x - 2$

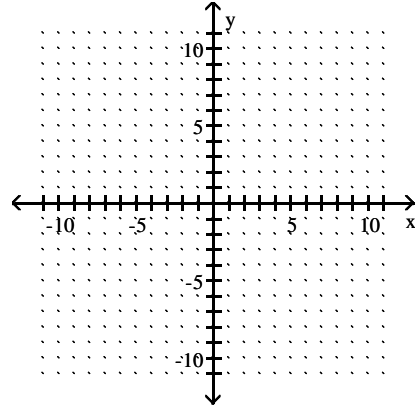

5) $y = 2x - 4$

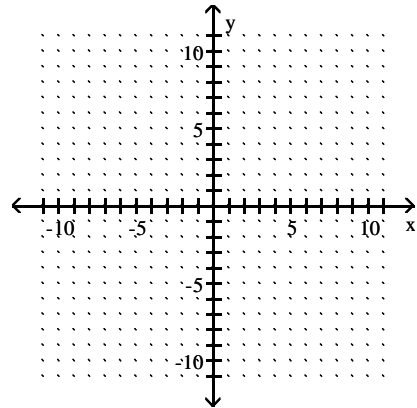

6) $y = 2x$

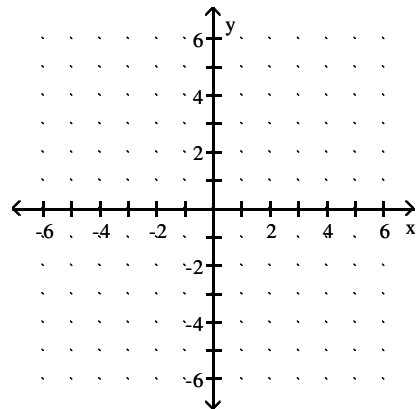

7) $y = -5x$

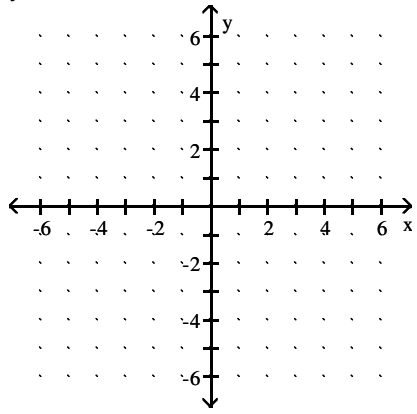

10) $y + 3 = x$

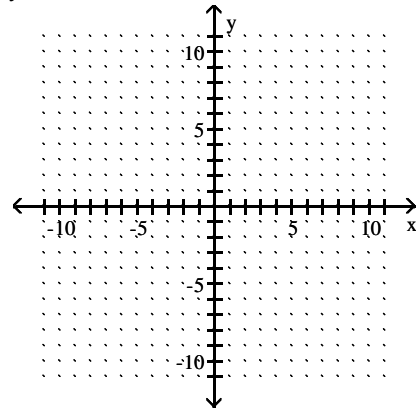

8) $y = \frac{1}{3}x$

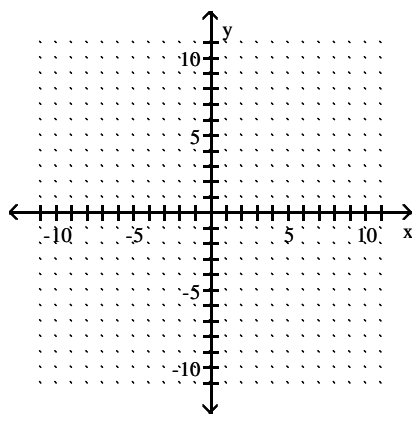

11) $y + 2 = x$

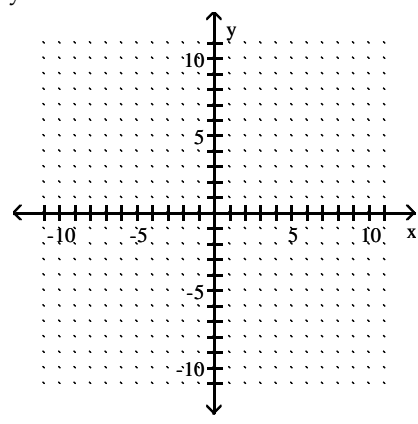

9) $y = \frac{1}{4}x$

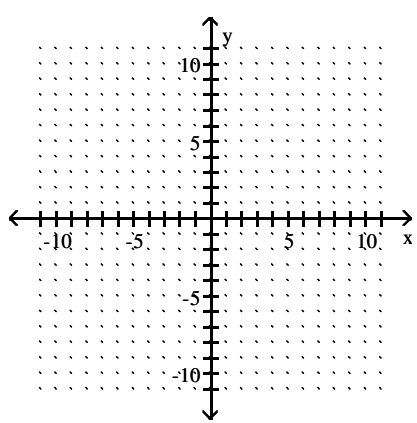

12) $3x - y = -3$

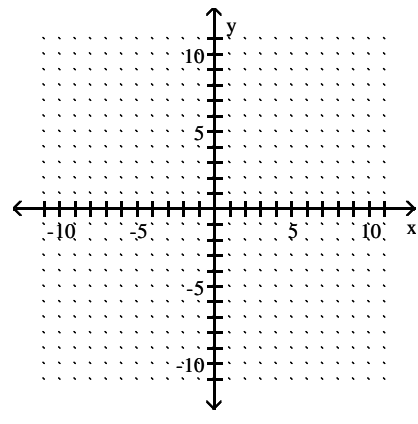

13) $2x - y = -2$

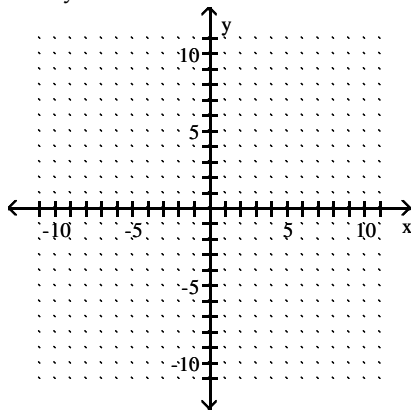

Graph the function.

16) $f(x) = |-3 - x|$

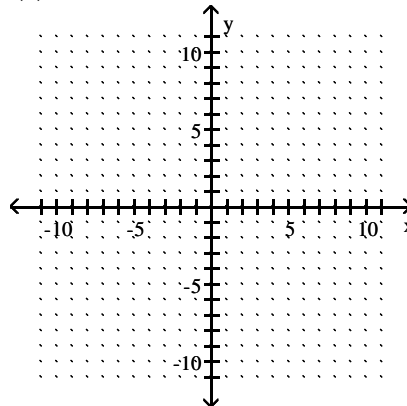

Graph the equation.

14) $y = x^2 - 1$

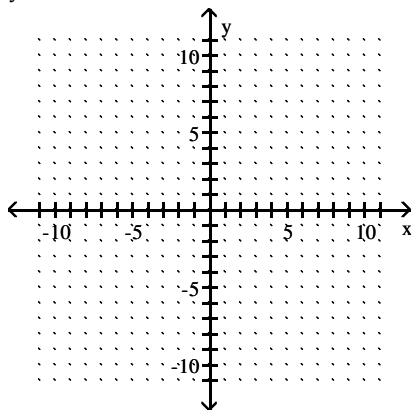

Graph.

17) $y = 1$

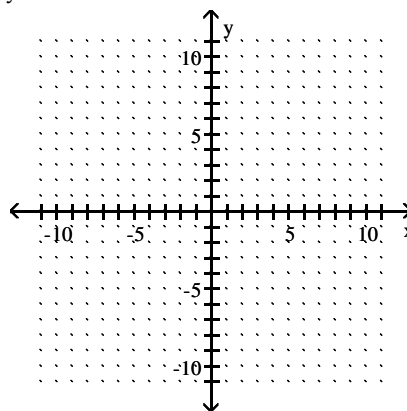

15) $y = \frac{1}{4}x^2$

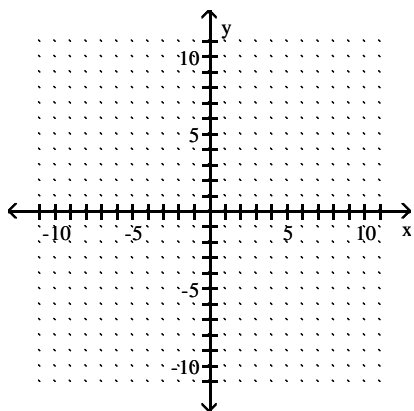

18) $x = 1$

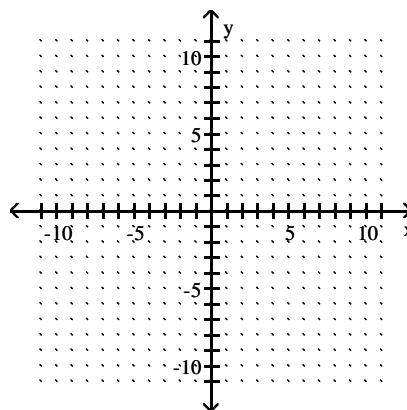

Graph the function.

19) $f(x) = |-8 - x|$

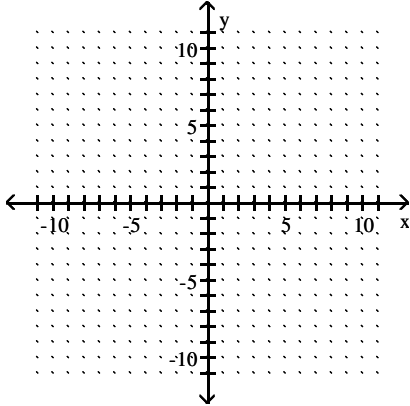

22) $y = 3x - 3$

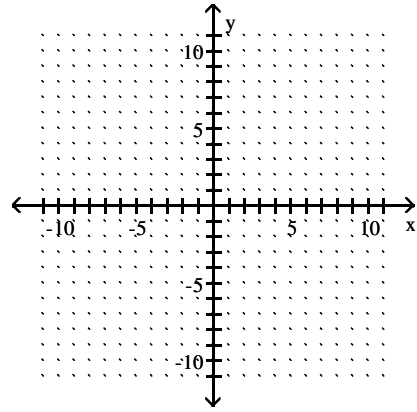

Graph.

20) $y = x - 7$

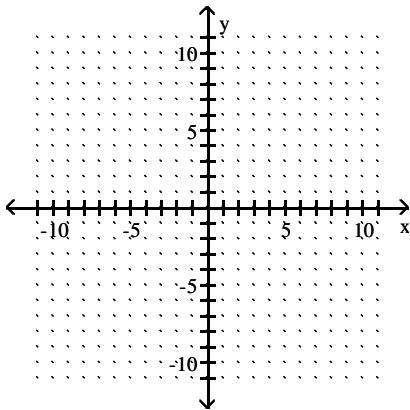

23) $y = 5x$

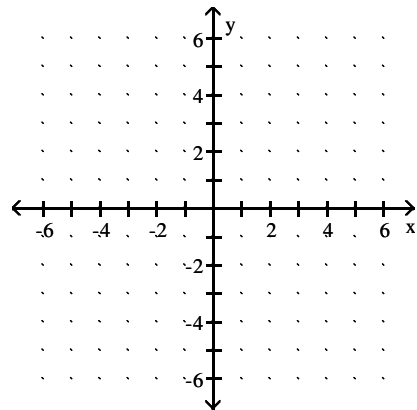

21) $y = 2x + 6$

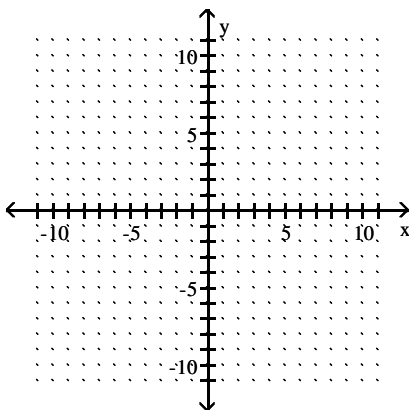

24) $y = -2x$

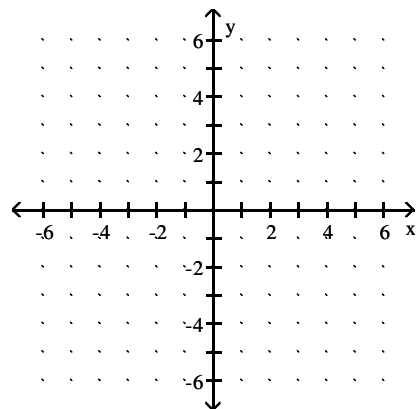

$$25) y = \frac{2}{5}x$$

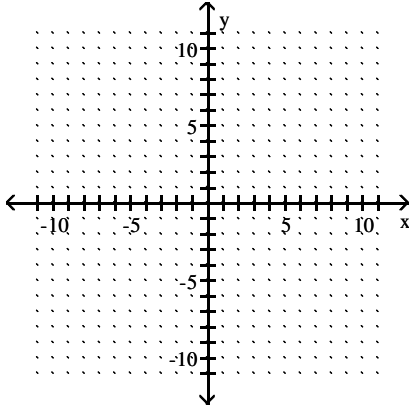

$$28) y - 6 = x$$

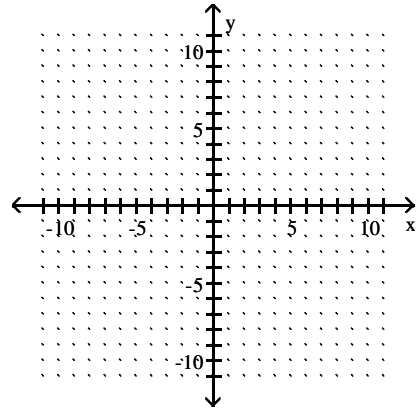

$$26) y = \frac{1}{2}x$$

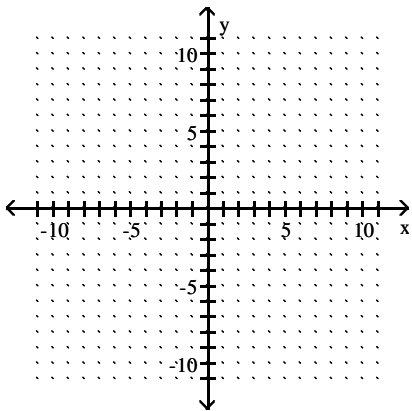

$$29) 2x - y = 6$$

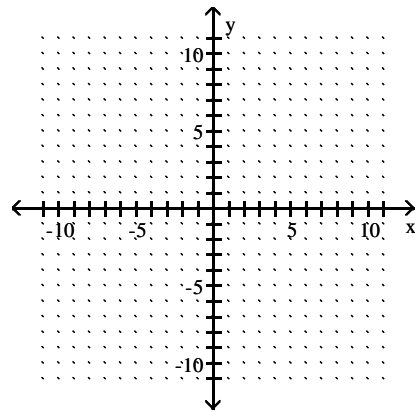

$$27) y - 2 = x$$

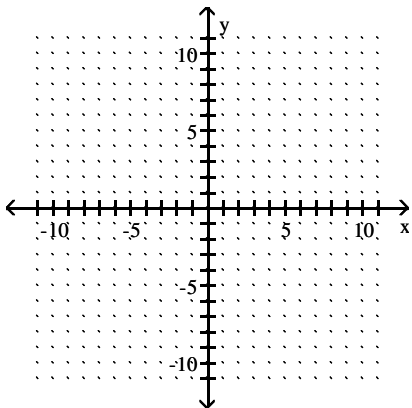

$$30) 2x - y = -2$$

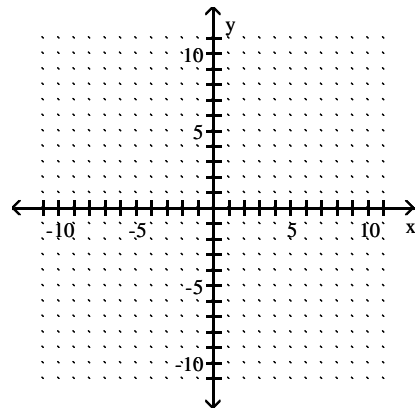

Graph the equation.

31) $y = x^2 + 3$

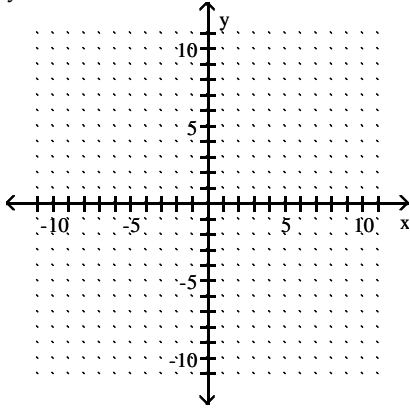

Graph.

34) $y = 2$

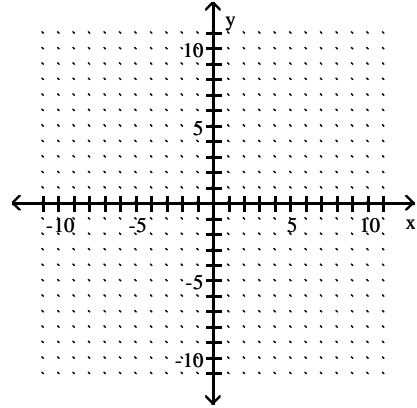

32) $y = \frac{1}{5}x^2$

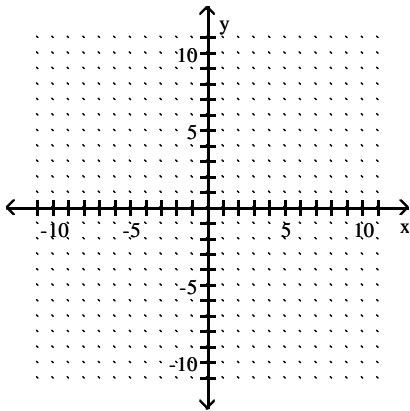

35) $x = -1$

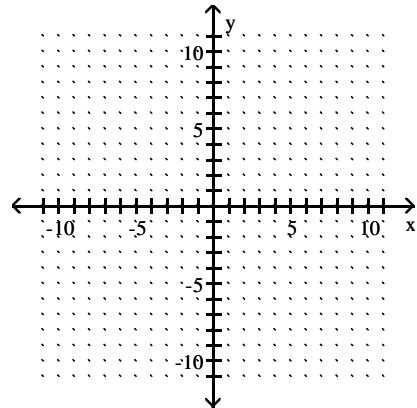

Graph the function.

33) $f(x) = |4 - x|$

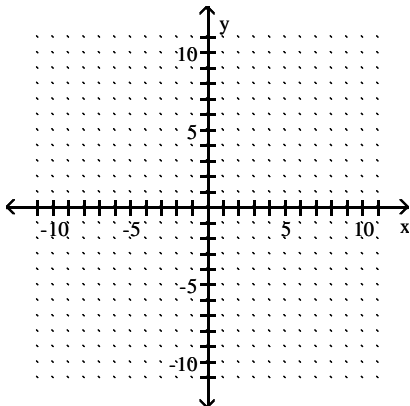

Graph the function.

36) $f(x) = |3 - x|$

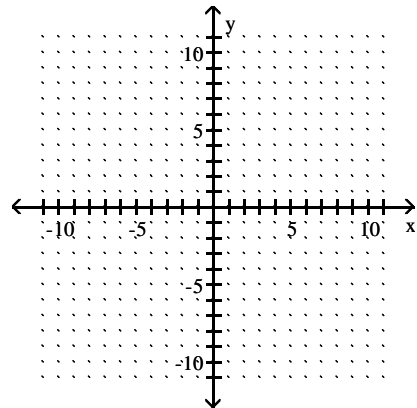

Answer Key

Testname: WS0.1V0.2TST

1)

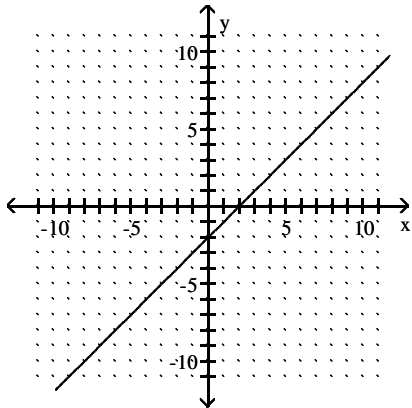

2)

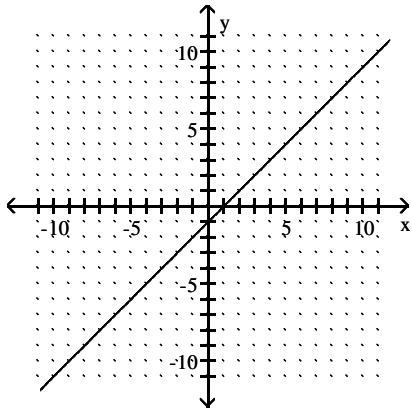

3)

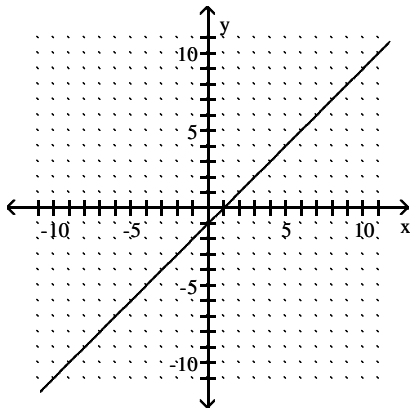

Answer Key

Testname: WS0.1V0.2TST

4)

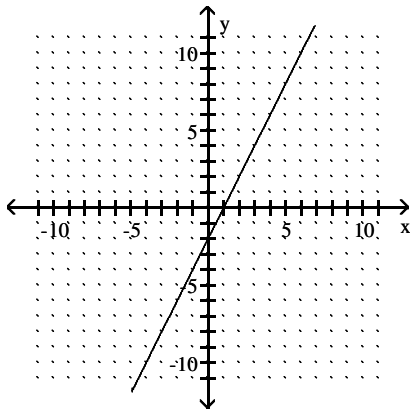

5)

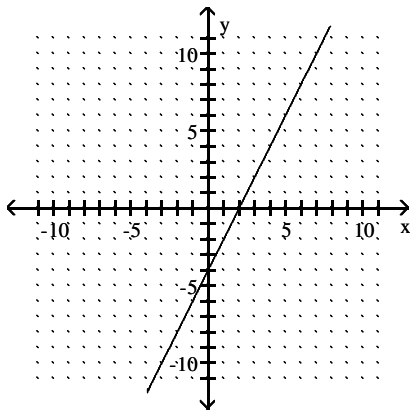

6)

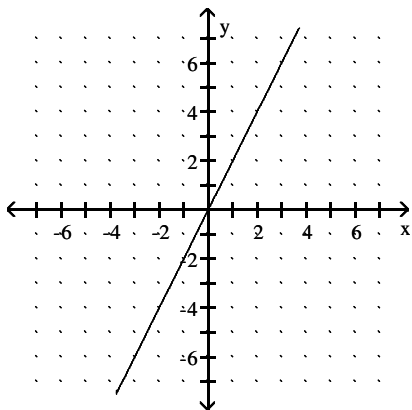

Answer Key

Testname: WS0.1V0.2TST

7)

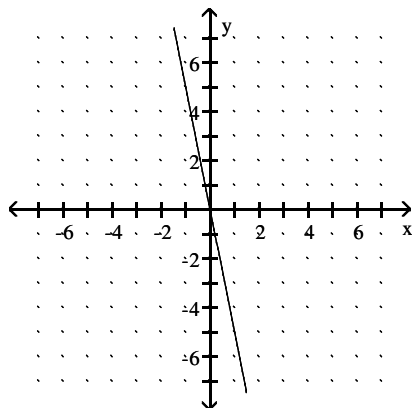

8)

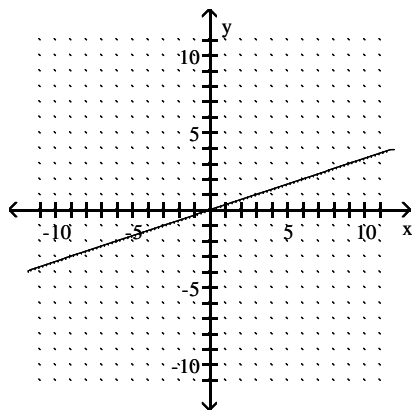

9)

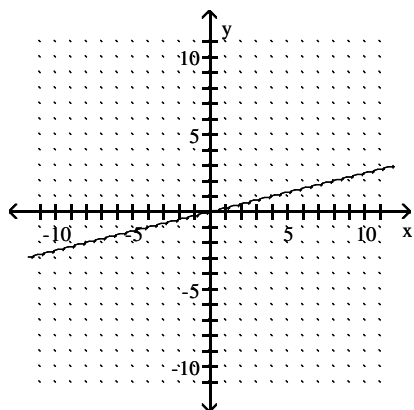

Answer Key

Testname: WS0.1V0.2TST

10)

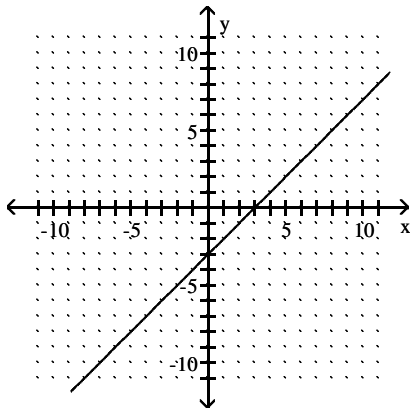

11)

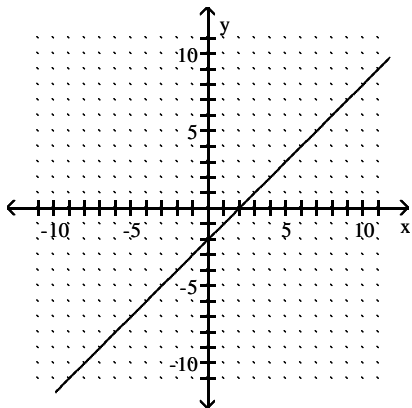

12)

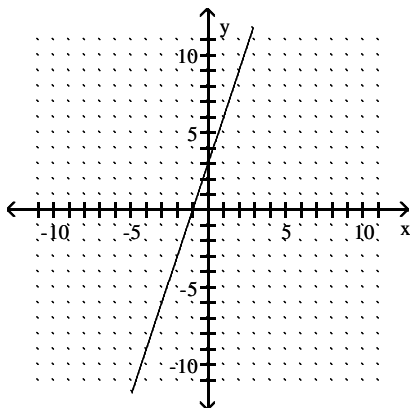

Answer Key

Testname: WS0.1V0.2TST

13)

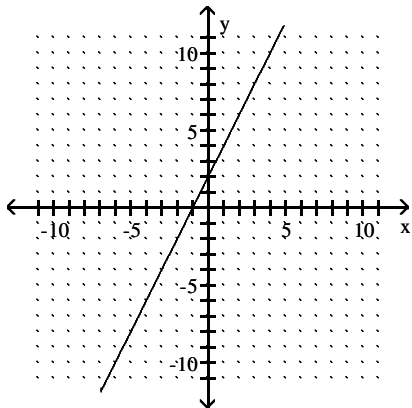

14)

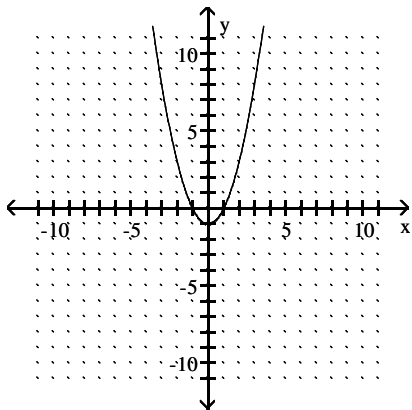

15)

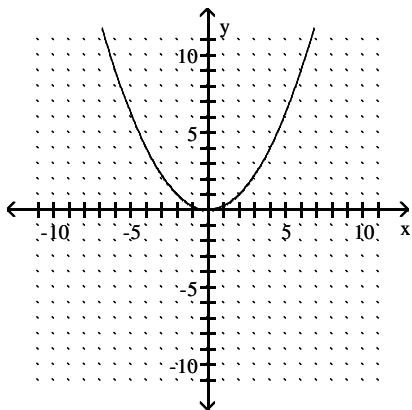

Answer Key

Testname: WS0.1V0.2TST

16)

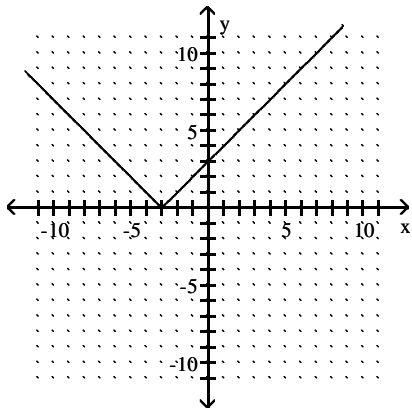

17)

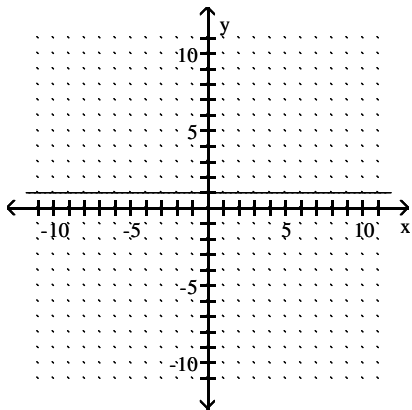

18)

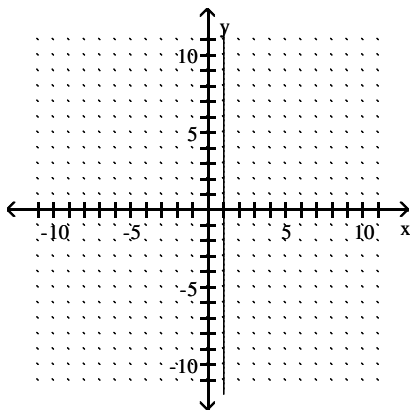

Answer Key

Testname: WS0.1V0.2TST

19)

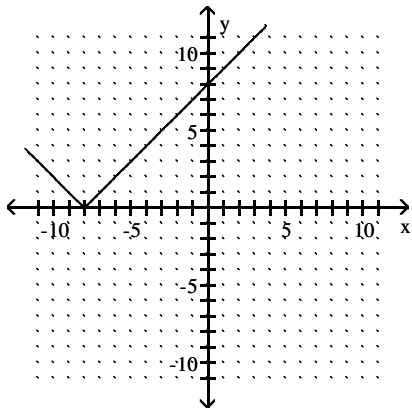

20)

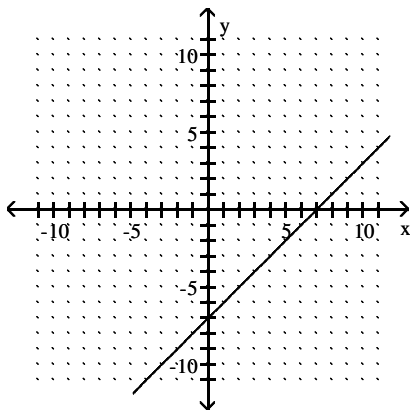

21)

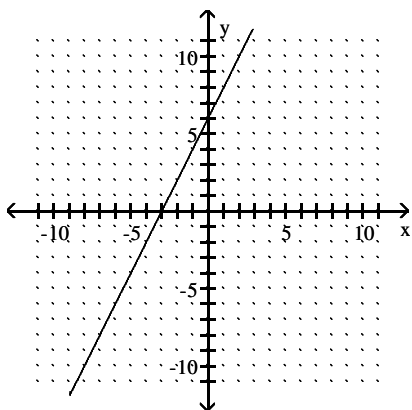

Answer Key

Testname: WS0.1V0.2TST

22)

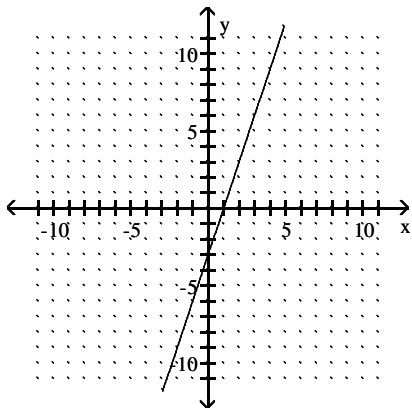

23)

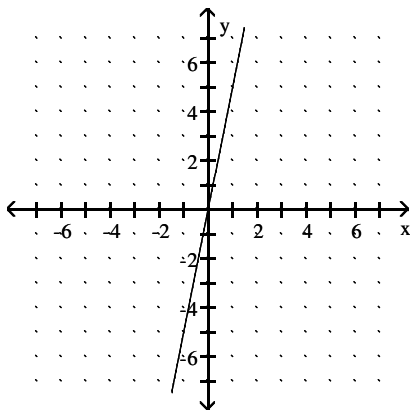

24)

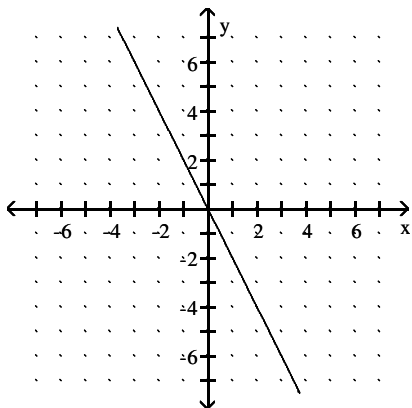

Answer Key

Testname: WS0.1V0.2TST

25)

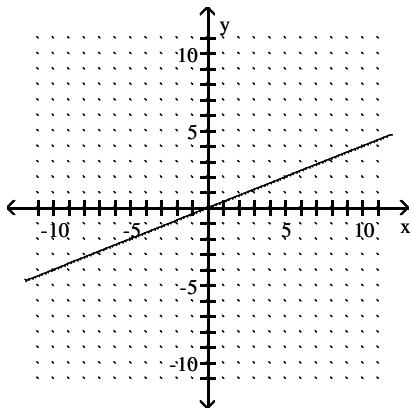

26)

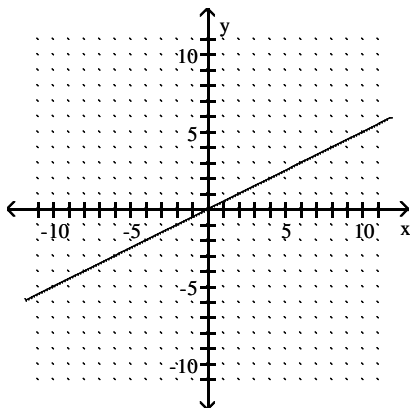

27)

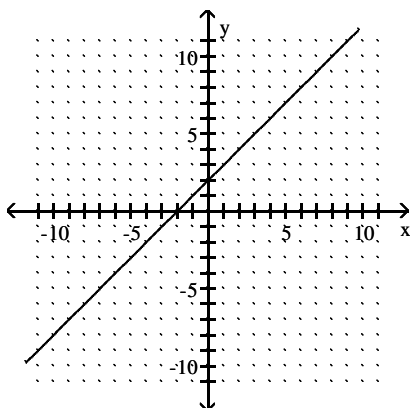

Answer Key

Testname: WS0.1V0.2TST

28)

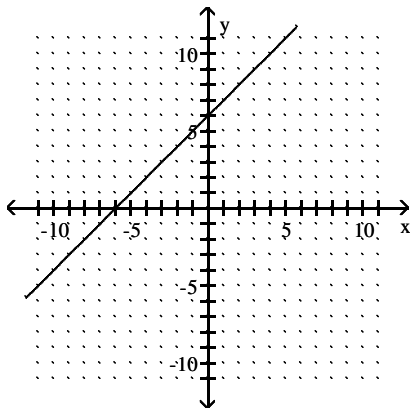

29)

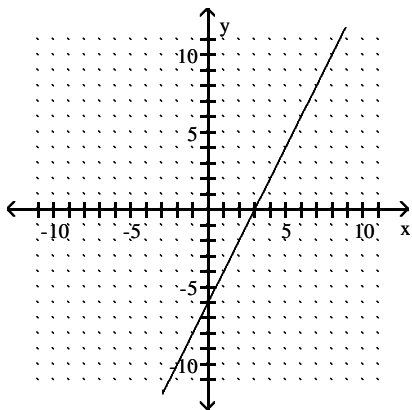

30)

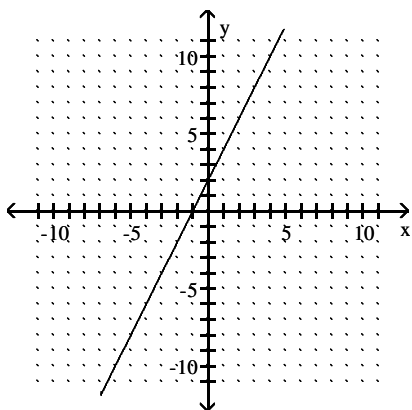

Answer Key

Testname: WS0.1V0.2TST

31)

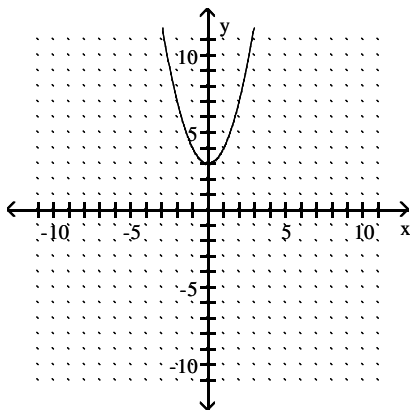

32)

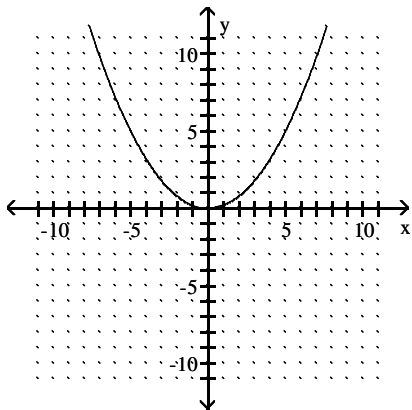

33)

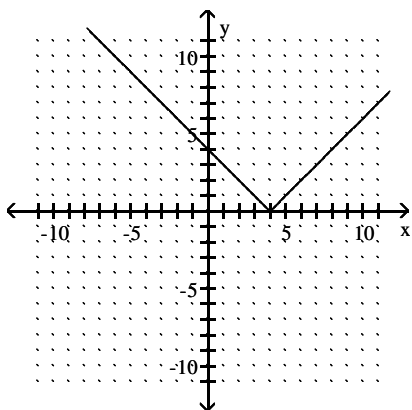

Answer Key

Testname: WS0.1V0.2TST

34)

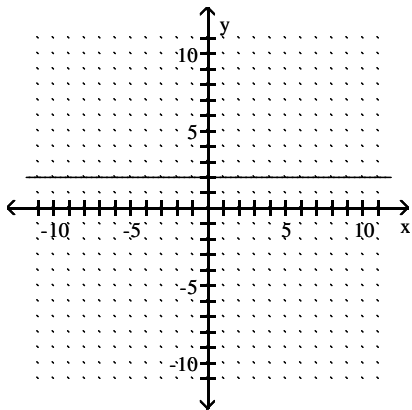

35)

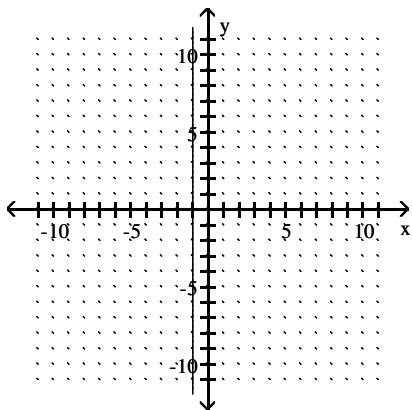

36)

